



ORIGINAL INSTRUCTIONS

Instruction Manual
Vacuum Gripper
ZXP7*-KA Series



The intended use of vacuum gripper is to mount on a collaborative robot and grip / release workpiece.

1 Safety Instructions

These safety instructions are intended to prevent hazardous situations and/or equipment damage. These instructions indicate the level of potential hazard with the labels of "Caution," "Warning" or "Danger." They are all important notes for safety and must be followed in addition to International Standards (ISO/IEC)¹⁾, and other safety regulations.

¹⁾ ISO 4414: Pneumatic fluid power — General rules and safety requirements for systems and their components.
ISO 4413: Hydraulic fluid power — General rules and safety requirements for systems and their components
IEC 60204-1: Safety of machinery - Electrical equipment of machines. (Part 1: General requirements)
ISO 10218-1: Robots and robotic devices - Safety requirements for industrial robots - Part 1: Robots.

- Refer to product catalogue, Operation Manual and Handling Precautions for SMC Products for additional information.
- Keep this manual in a safe place for future reference.

Danger	Danger indicates a hazard with a high level of risk which, if not avoided, will result in death or serious injury.
Warning	Warning indicates a hazard with a medium level of risk which, if not avoided, could result in death or serious injury.
Caution	Caution indicates a hazard with a low level of risk which, if not avoided, could result in minor or moderate injury.

Warning

- Always ensure compliance with relevant safety laws and standards.
- All work must be carried out in a safe manner by a qualified person in compliance with applicable national regulations.

2 Specifications

2.1 Common specifications

Mechanical interface	Compliant with "ISO 9409-1-31.5-4-M5"
Fluid	Air
Operating temperature range [°C]	5 to 50
Weight [g]	ZXP7N-X1*-KA: 427 ZXP7A-X1*-KA: 659
Example) ZXP7A-ZPB25JS-X1*-KA ^{Note 1)}	712
Max. workload [kg] ^{Note 2)}	7
Impact / Vibration resistance [m/s ²] ^{Note 3)}	150 / 30
Air supply port (P)	One touch fitting (Φ4) Side
Release pressure supply port (PD)	One touch fitting (Φ4) Internal

Table 1.

Note 1) The weight changes by the selected suction cup.

Note 2) Limited by the cup diameter, mounting orientation or workpiece. The weight of the workpiece shall be maximum workload or less. Gripping or transfer of workload exceeding the maximum workload leads to the decrease of vacuum due to air leakage.

2 Specifications - continued

Note 3) Impact resistance: The characteristics are satisfied after tested one time in each of the X, Y and Z directions without energization (Initial value).
Vibration resistance: The characteristics are satisfied after tested a one sweep in each of the X, Y and Z directions at 10 to 500 Hz without energization (Initial value).

2.2 Ejector specifications

Max. vacuum pressure [kPa] ^{Note 4)}	-84
Max. suction flow [L/min(ANR)] ^{Note 4)}	17
Air consumption [L/min(ANR)] ^{Note 4)}	57
Supply pressure range [MPa]	0.3 to 0.55
Standard supply pressure [MPa] ^{Note 5)}	0.5

Table 2.

Note 4) Values at the standard supply pressure. Values are based on standard of SMC measurements. They depend on atmospheric pressure (weather, altitude, etc.) and measurement method.

Note 5) This shows the pressure just before the supply (P) port. The performance such as vacuum pressure may reduce, depending on supply air capacity, the piping volume (piping length and diameter) and affection of air consumption of other devices which operate at the same time.

2.3 Pressure switch specifications

Model	ZSE20-*-*-M5-LA2
Power supply voltage [V]	12 to 24 DC ± 10%, Ripple (p-p) 10% or less
Rated pressure range [kPa]	0 to -101
Display Accuracy [%]	±2 F.S. ±1 digit (Ambient temperature of 25 ±3°C)
Repeatability [%]	±0.2 F.S. ±1 digit
Temperature characteristics [%]	±2 F.S. (25°C standard)

Table 3.

3 Installation

3.1 Installation

Warning

- Do not install the product unless the safety instructions have been read and understood.

3.2 Parts included in the package

- 1) Robot mounting flange: 1 pc.

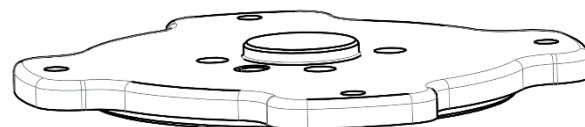

- 2) Vacuum gripper: 1 pc.

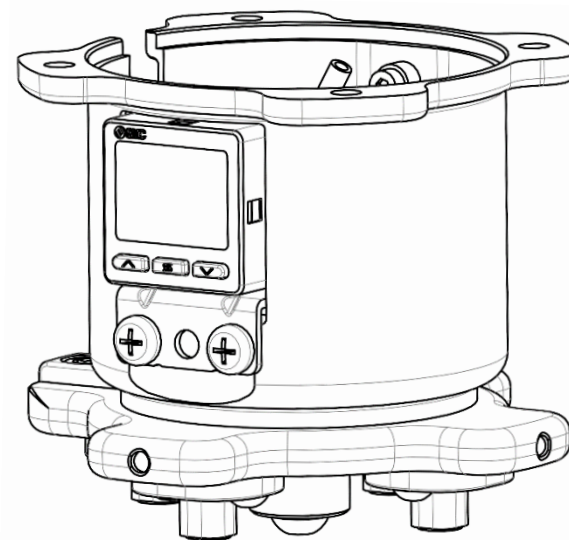

- 3) Tie band 1 pc.



3 Installation - continued

- 4) Suction cup with adapter: 4 pcs.
- 5) Hexagon socket head cap screw

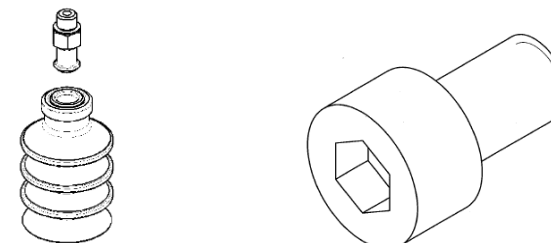

(M5x10): 8 pcs.

(When "suction cup series" is selected.)

- 6) Plug: 4 pcs.

- 7) Parallel pin (5x10): 1 pc.

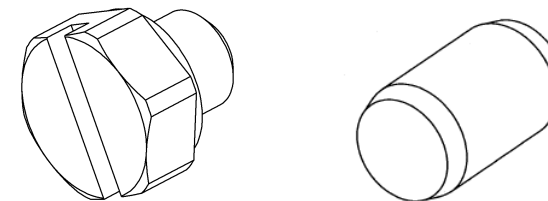

(When "cup mounting flange shape" is selected)

Used for decreasing the number of suction cups.

3.3 Mounting

- Mounting procedure

- 1) Confirm the gasket seal on the adapter, then mount 4 cups with adapter to the vacuum gripper. (Tightening torque: 1N · m or tighten for 45 degrees using a spanner after tightening by hand)
- 2) Mount parallel pin to the robot tool flange pin hole.

- 3) Align the parallel pin of the robot tool flange with the robot mounting flange and assemble them with bolts included in the accessories. (Tightening torque: 3.0+/-0.3 Nm)
- 4) Tighten the vacuum gripper to the robot mounting flange. (Tightening torque: 3.0+/-0.3 Nm)

- Removal procedure

Removal should be performed by following the mounting procedure in reverse.

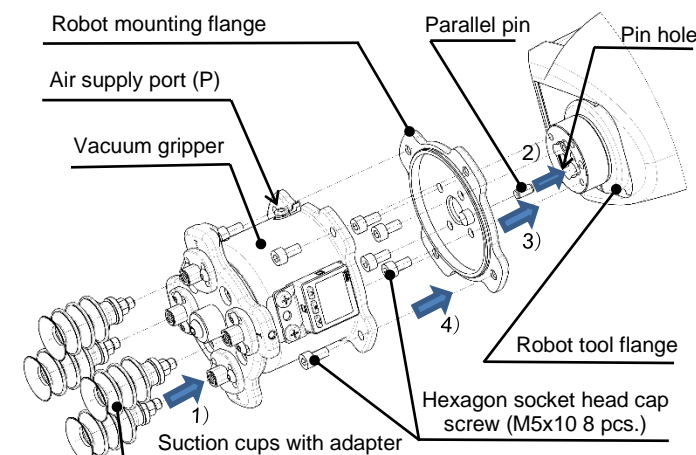
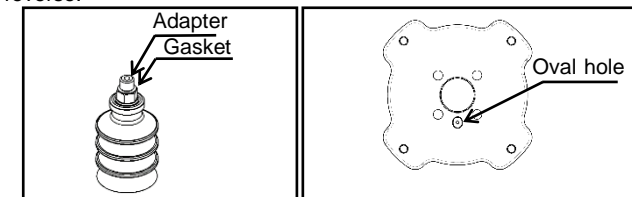

Figure 1.

3 Installation - continued

3.4 Wiring

Caution

- Do not lift up the vacuum gripper by holding this cable. Otherwise it can cause open circuit.
- For wiring between vacuum gripper and the sensor harness from duAro arm, refer to duAro's instruction manual.

Conductor cross section [mm ²]	0.15 (AWG26)	
Insulator	O.D. [mm]	1.0
	Color	Brown, Blue, Black, White, Gray (5-core)
Sheath	Finished O.D.	Φ3.4
Lead wire length		2m (Tip loose wire)

Table 4.

- Internal Circuits and Wiring Examples:

NPN (1 output)

PNP (1 output)

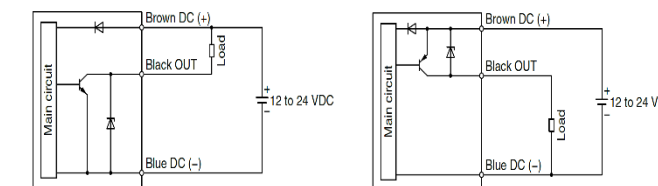

Figure 2.

3.5 Circuit diagram

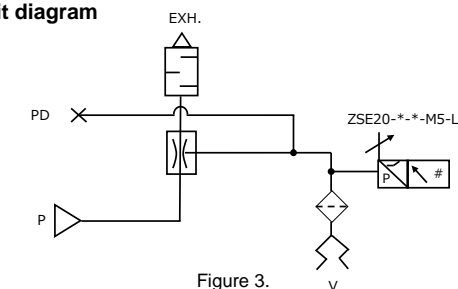

Figure 3.

3.6 Piping

Caution

- Before connecting piping make sure to clean up chips, cutting oil, dust etc.
- When installing piping or fittings, ensure sealant material does not enter inside the port. When using seal tape, leave 1 thread exposed on the end of the pipe/fitting.
- Tighten fittings to the specified tightening torque.
- Tubing
Connect a tube (applicable tube O.D. Φ4) to the air pressure supply port (P). When you remove the tube, push the release button and pull out the tube.
- When release supply pressure is necessary, remove plug (part No.: KQ2P-04) and connect Φ4 tube to release pressure supply port (PD). Tie and fix the Φ4 tube and switch cable by using in the accessory tie band after connecting Φ4 tube.

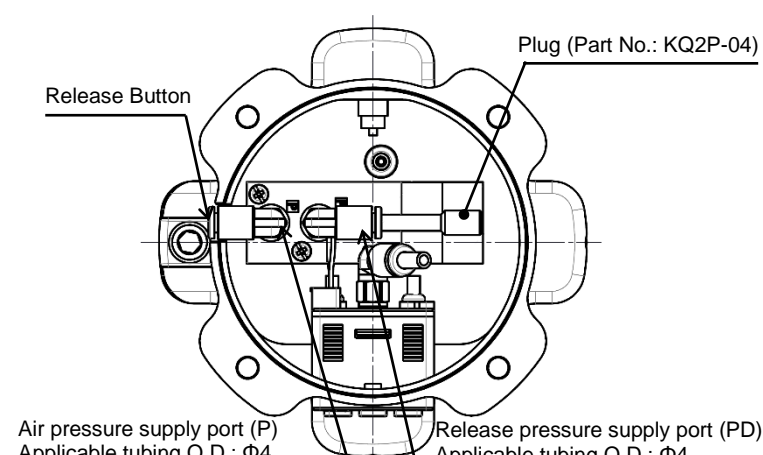

Figure 4.

3 Installation - continued

3.7 Environment

Warning

- Do not use in an environment where corrosive gases, chemicals, salt water or steam are present.
- Do not use in an explosive atmosphere.
- Do not expose to direct sunlight. Use a suitable protective cover.
- Do not install in a location subject to vibration or impact in excess of the product's specifications.
- Do not mount in a location exposed to radiant heat that would result in temperatures in excess of the product's specifications.
- Do not use the product in a place where the product could be splashed by oil or chemicals.
- Do not use in an area where surges are generated.

4 How to Order

Refer to catalogue for 'How to Order'.

5 Outline Dimensions

Refer to catalogue for outline dimensions.

6 Maintenance

6.1 Maintenance for vacuum gripper

Caution

- Check before and after the maintenance work
When the product is to be removed, turn off the power supply, and be sure to cut off the supply pressure and exhaust the compressed air. Confirm that the air is released to atmosphere.
When mounting the product after the maintenance work, supply compressed air, connect to the power, check if it functions properly and have a leakage inspection.
- Maintenance should be performed according to the procedure indicated in the Operation Manual.
Improper handling can cause damage and malfunction of equipment and machinery.
- Maintenance work
Compressed air can be dangerous when handled incorrectly. Therefore, in addition to observing the product specifications, replacement of maintenance activities should be performed by personnel with sufficient knowledge and experience pertaining to pneumatic equipment.
- Draining
Remove condensate from air filters and mist separators regularly. If the collected drainage is drained to the downstream side, it can stick inside of the product, causing operation failure and failure to reach the specified vacuum pressure.
- After installation and maintenance, apply operating pressure and power to the equipment and perform appropriate functional and leakage tests to make sure the equipment is installed correctly.
- If any electrical connections are disturbed during maintenance, ensure they are reconnected correctly, and safety checks are carried out as required to ensure continued compliance with applicable national regulations.
- Do not disassemble or modify the product, other than the replacement parts specified in the Operation Manual.

6.2 Maintenance for suction cup

Caution

- Suction cups are disposable. Replace them on a regular basis.

Continued use of suction cups will cause wear and tear on the gripping surface, and the exterior dimensions will gradually get smaller and smaller. As the cups' diameter gets smaller, their lifting force will decrease, though gripping will still remain possible.

It is extremely difficult to provide advice on the frequency of suction cup replacement. This is because there are numerous factors at work, including surface roughness, operating environment (temperature, humidity, ozone, solvents, etc.), and operating conditions (vacuum pressure, workpiece weight, pressing force of the suction cups on the workpieces, presence or absence of a buffer, etc.).

6 Maintenance - continued

The weakening of bent parts or the wear or sticking of rubber parts may occur with the bellows type cup.

The customer should decide when suction cups should be replaced, based on their condition at the time of initial use. The bolts may become loose depending on the operating conditions and environment. Ensure the maintenance is performed regularly.

6.3 Replacement of suction cup

- Pull the lock ring upward, and, after lifting it up to the adapter, remove the old cup by pulling it downward.
- While holding the lock ring in the raised position place a new cup onto the adapter.
- Confirm that the cup is securely in place, and then return the lock ring to its original position.

Note) The cup without lock ring is just inserted to the end of the adapter.

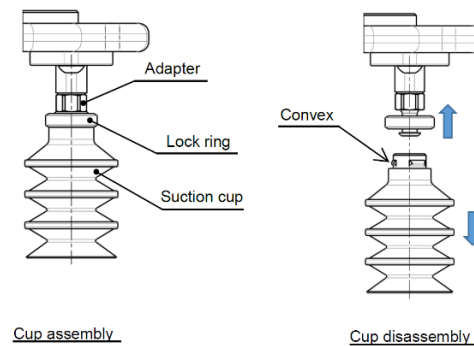

Figure 5.

7 Limitations of Use

7.1 Limited warranty and disclaimer/compliance requirements

Refer to Handling Precautions for SMC Products.

7.2 Exhaust Noise

When vacuum ejector generates vacuum, noise can be heard from the exhaust port when the standard supply pressure is close to the pressure that generates peak vacuum pressure making vacuum pressure unstable. If the vacuum pressure range is adequate for gripping, there should not be a problem. If the noise causes a problem or affects the setting of the pressure switch, change the supply pressure slightly to avoid the pressure range of the noise.

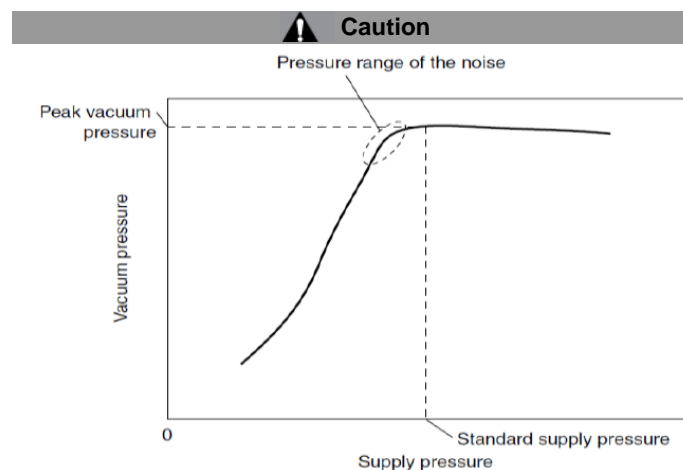

Figure 6.

8 Product Disposal

This product shall not be disposed of as municipal waste. Check your local regulations and guidelines to dispose this product correctly, in order to reduce the impact on human health and the environment.

9 Contacts

Refer to www.smcworld.com or www.smc.eu for your local distributor/importer.

SMC Corporation

URL : <https://www.smcworld.com> (Global) <https://www.smc.eu> (Europe)
SMC Corporation, 4-14-1, Sotokanda, Chiyoda-ku, Tokyo 101-0021, Japan
Specifications are subject to change without prior notice from the manufacturer.
© SMC Corporation All Rights Reserved.
Template DKP50047-F-085N